

STAINLESS STEEL HEAVY DUTY WORK TABLES

With Adjustable Undershelf

FEATURES:

MSLAG: Top is furnished with 1 5/8" square bend on sides and 1 5/8" sanitary rolled rim on front and rear & square sides.

FMSLAG: Top is furnished with 1 5/8" square bend on sides and 1 5/8" sanitary rolled rim on front with 1 1/2" Rear Splash.

KMSLAG: Top is furnished with 1 5/8" square bend on sides and 1 5/8" sanitary rolled rim on front with 5" Rear Splash.

Two hat-channels stud welded under tabletop to reinforce and maintain a level work surface.

Aluminum die cast "leg-to-shelf" clamp secures shelf to leg eliminating unsightly nuts and bolts. Undershelf is fully adjustable.

CONSTRUCTION:

All TIG welded. Exposed weld areas polished to match adjacent surface.

Top is sound deadened.

Roll formed embossed galvanized hat channels are secured to top by means of structural adhesive and weld studs.

Gussets welded to support hat channels.

MATERIAL:

TOP: 16 gauge stainless steel type "304" series.

SHELF: 18 gauge stainless steel.

LEGS: 1 5/8" diameter tubular Stainless steel. Stainless steel gussets. 1" adjustable stainless steel bullet feet.

Item #: _____ Qty #: _____

Model #: _____

Project #: _____



Stainless Steel Bullet Feet
Standard On
TMSLAG, TFMSLAG
& TKMSLAG Series



FLAT TOP
MSLAG-X Series



1-1/2" BACKSPLASH
FMSLAG-X Series



5" BACKSPLASH
KMSLAG-X Series

	L	Model #		WT.	Cu. Ft.	Model #		WT.	Cu. Ft.
		Model #	Model #			Model #	Model #		
24" WIDE	24"	FLAT TOP	1-1/2" SPLASH	43 lbs.	4	5" SPLASH		47 lbs.	6
	30"	MSLAG-242-X	FMSLAG-242-X	52 lbs.	4	KMSLAG-242-X		55 lbs.	6
	36"	MSLAG-240-X	FMSLAG-240-X	57 lbs.	4	KMSLAG-240-X		62 lbs.	6
	48"	MSLAG-243-X	FMSLAG-243-X	70 lbs.	6	KMSLAG-243-X		75 lbs.	9
	60"	MSLAG-244-X	FMSLAG-244-X	80 lbs.	7	KMSLAG-244-X		90 lbs.	11
	72"	MSLAG-245-X	FMSLAG-245-X	96 lbs.	8	KMSLAG-245-X		103 lbs.	13
	84"	MSLAG-246-X	FMSLAG-246-X	109 lbs.	10	KMSLAG-246-X		118 lbs.	15
	96"	MSLAG-247-X	FMSLAG-247-X	130 lbs.	11	KMSLAG-247-X		139 lbs.	17
30" WIDE	24"	MSLAG-248-X*	FMSLAG-248-X*	46 lbs.	5	KMSLAG-248-X*		51 lbs.	8
	30"	MSLAG-302-X	FMSLAG-302-X	60 lbs.	5	KMSLAG-302-X		63 lbs.	8
	36"	MSLAG-300-X	FMSLAG-300-X	69 lbs.	5	KMSLAG-300-X		74 lbs.	8
	48"	MSLAG-303-X	FMSLAG-303-X	85 lbs.	7	KMSLAG-303-X		91 lbs.	11
	60"	MSLAG-304-X	FMSLAG-304-X	103 lbs.	8	KMSLAG-304-X		109 lbs.	13
	72"	MSLAG-305-X	FMSLAG-305-X	120 lbs.	10	KMSLAG-305-X		127 lbs.	16
	84"	MSLAG-306-X	FMSLAG-306-X	136 lbs.	12	KMSLAG-306-X		139 lbs.	18
	96"	MSLAG-307-X	FMSLAG-307-X	161 lbs.	13	KMSLAG-307-X		166 lbs.	20
36" WIDE	36"	MSLAG-308-X*	FMSLAG-308-X*	75 lbs.	6	NOT AVAILABLE			
	48"	MSLAG-363-X	FMSLAG-363-X	94 lbs.	9				
	60"	MSLAG-364-X	FMSLAG-364-X	112 lbs.	10				
	72"	MSLAG-365-X	FMSLAG-365-X	132 lbs.	12				
	96"	MSLAG-366-X	FMSLAG-366-X	179 lbs.	16				

*All 8 ft. Tables Provided With 6 Legs

DETAILS and SPECIFICATIONS

TOL ± .500"

ALL DIMENSIONS ARE TYPICAL

MSLAG SERIES - Flat Top

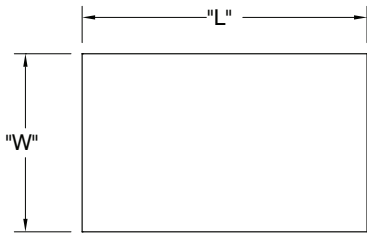

- Rolled Edge At Front & Rear
- Ends Turned Down Square

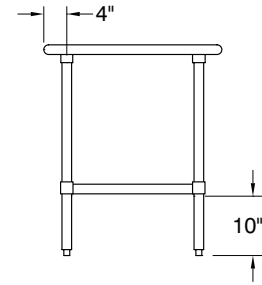
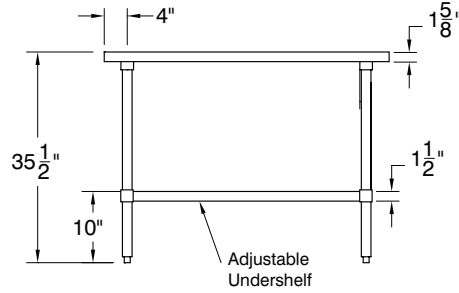

FMSLAG SERIES - 1 1/2" Backsplash

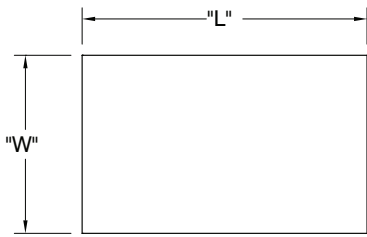

- Rolled Edge At Front
- 1 1/2" Turn Up At Rear
- Ends Turned Down Square

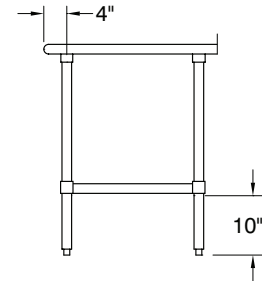
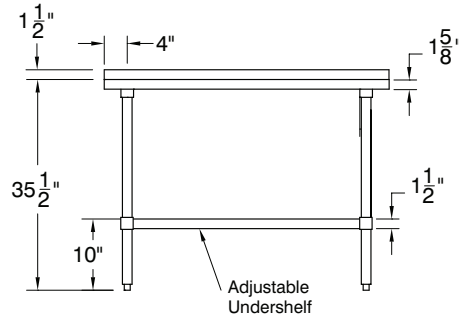

KMSLAG SERIES- 5" Backsplash

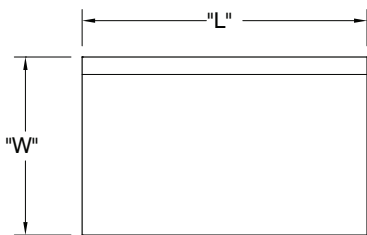

- Rolled Edge At Front
- 5" Splash At Rear
- Ends Turned Down Square

