



# STAINLESS STEEL HEAVY DUTY WORK TABLES With Adjustable Undershef

## FEATURES:

**MSLAG:** Top is furnished with 1 5/8" square bend on sides and 1 5/8" sanitary rolled rim on front and rear & square sides.

**FMSLAG:** Top is furnished with 1 5/8" square bend on sides and 1 5/8" sanitary rolled rim on front with 1 1/2" Rear Splash.

**KMSLAG:** Top is furnished with 1 5/8" square bend on sides and 1 5/8" sanitary rolled rim on front with 5" Rear Splash.

Two hat-channels stud welded under tabletop to reinforce and maintain a level work surface.

Aluminum die cast "leg-to-shelf" clamp secures shelf to leg eliminating unsightly nuts and bolts. Undershef is fully adjustable.

## CONSTRUCTION:

All TIG welded. Exposed weld areas polished to match adjacent surface.

Top is sound deadened.

Roll formed embossed galvanized hat channels are secured to top by means of structural adhesive and weld studs.

Gussets welded to support hat channels.

## MATERIAL:

**TOP:** 16 gauge stainless steel type "304" series.

**SHELF:** 18 gauge stainless steel.

**LEGS:** 1 5/8" diameter tubular Stainless steel. Stainless steel gussets. 1" adjustable stainless steel bullet feet.

Item #: \_\_\_\_\_ Qty #: \_\_\_\_\_  
 Model #: \_\_\_\_\_  
 Project #: \_\_\_\_\_



Stainless Steel Bullet Feet  
Standard On  
TMSLAG, FMSLAG  
& TKMSLAG Series



**FLAT TOP**  
MSLAG-X Series



**1-1/2" BACKSPLASH**  
FMSLAG-X Series



**5" BACKSPLASH**  
KMSLAG-X Series

	L	Model #	Model #	WT.	Cu. Ft.	Model #	WT.	Cu. Ft.
<b>24" WIDE</b>	24"	MSLAG-242-X	FMSLAG-242-X	43 lbs.	4	KMSLAG-242-X	47 lbs.	6
	30"	MSLAG-240-X	FMSLAG-240-X	52 lbs.	4	KMSLAG-240-X	55 lbs.	6
	36"	MSLAG-243-X	FMSLAG-243-X	57 lbs.	4	KMSLAG-243-X	62 lbs.	6
	48"	MSLAG-244-X	FMSLAG-244-X	70 lbs.	6	KMSLAG-244-X	75 lbs.	9
	60"	MSLAG-245-X	FMSLAG-245-X	80 lbs.	7	KMSLAG-245-X	90 lbs.	11
	72"	MSLAG-246-X	FMSLAG-246-X	96 lbs.	8	KMSLAG-246-X	103 lbs.	13
	84"	MSLAG-247-X	FMSLAG-247-X	109 lbs.	10	KMSLAG-247-X	118 lbs.	15
	96"	MSLAG-248-X*	FMSLAG-248-X*	130 lbs.	11	KMSLAG-248-X*	139 lbs.	17
<b>30" WIDE</b>	24"	MSLAG-302-X	FMSLAG-302-X	46 lbs.	5	KMSLAG-302-X	51 lbs.	8
	30"	MSLAG-300-X	FMSLAG-300-X	60 lbs.	5	KMSLAG-300-X	63 lbs.	8
	36"	MSLAG-303-X	FMSLAG-303-X	69 lbs.	5	KMSLAG-303-X	74 lbs.	8
	48"	MSLAG-304-X	FMSLAG-304-X	85 lbs.	7	KMSLAG-304-X	91 lbs.	11
	60"	MSLAG-305-X	FMSLAG-305-X	103 lbs.	8	KMSLAG-305-X	109 lbs.	13
	72"	MSLAG-306-X	FMSLAG-306-X	120 lbs.	10	KMSLAG-306-X	127 lbs.	16
	84"	MSLAG-307-X	FMSLAG-307-X	136 lbs.	12	KMSLAG-307-X	139 lbs.	18
	96"	MSLAG-308-X*	FMSLAG-308-X*	161 lbs.	13	KMSLAG-308-X*	166 lbs.	20
<b>36" WIDE</b>	36"	MSLAG-363-X	FMSLAG-363-X	75 lbs.	6	NOT AVAILABLE		
	48"	MSLAG-364-X	FMSLAG-364-X	94 lbs.	9			
	60"	MSLAG-365-X	FMSLAG-365-X	112 lbs.	10			
	72"	MSLAG-366-X	FMSLAG-366-X	132 lbs.	12			
	96"	MSLAG-368-X*	FMSLAG-368-X*	179 lbs.	16			

\*All 8 ft. Tables Provided With 6 Legs



Customer Service Available To Assist You **1-800-645-3166** 8:30 am - 8:00 pm E.S.T.

For Orders & Customer Service:

Email: customer@advancetabco.com or Fax: 631-242-6900

For Smart Fabrication™ Quotes:

Email: smartfab@advancetabco.com or Fax: 631-586-2933

# DETAILS and SPECIFICATIONS

TOL ± .500"

ALL DIMENSIONS ARE TYPICAL

## MSLAG SERIES - Flat Top

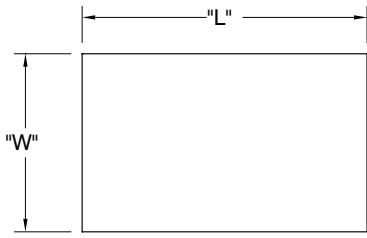

- Rolled Edge At Front & Rear
- Ends Turned Down Square

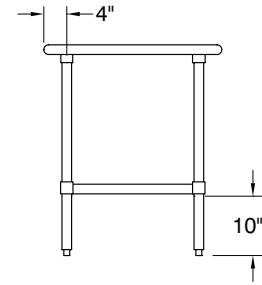
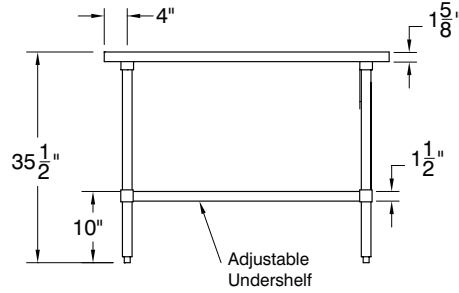

## FMSLAG SERIES - 1 1/2" Backsplash

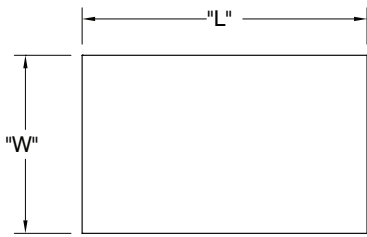

- Rolled Edge At Front
- 1 1/2" Turn Up At Rear
- Ends Turned Down Square

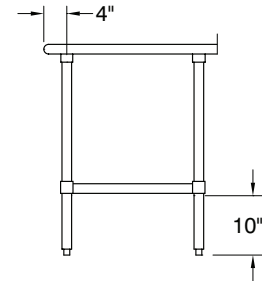
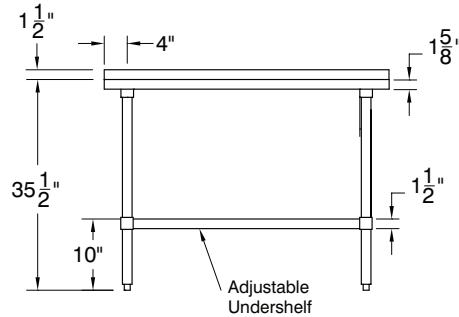

## KMSLAG SERIES- 5" Backsplash

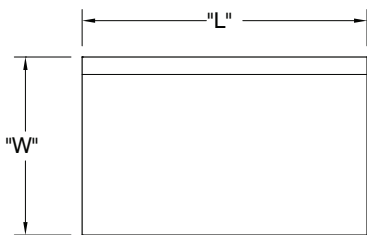

- Rolled Edge At Front
- 5" Splash At Rear
- Ends Turned Down Square

